

DATA SHEET

- Type.....E2-ASNA 90L-4
- Reference standard..... IEC 60034-1; 60034-30
60079-0;
60079-15
- Rated output..... 1.5 kW
- Rated stator voltage.....400V
- Stator current at 100% load3.33 [A]
- Number of poles.....4
- Rated speed.....1420 rev/min
- Rated frequency.....50 Hz
- Efficiency at 100%, 75%, 50% load.....82.8%, 82.4%, 80.4%
- Power factor at 100% load.....0.78
- Break-down torque.....2.9 x Mn
- Locked rotor torque.....2.9 x Mn
- Locked rotor current.....6.2 x In
- Rotor inertia.....0.00706 kgm²
- Insulation class.....F
- Direction of rotation.....Both(CW&CCW)
- Protection degree.....≥IP55
- Mounting.....IM
- Cooling method.....IC 411
- Max. ambient temperature.....+40°C
- Altitude.....1000m
- Bearing type.....6305 2Z drive end
6305 2Z non drive end
- Weight.....33Kg
- Outline drawing.....Page 2
- Vibration level :.....A (acc.IEC 60034-14)
- Noise levelacc.IEC 60034-9
- Cable entries.....1xM25x1.5
- Climate executionN

**The overall and mounting dimensions
IM 1001**

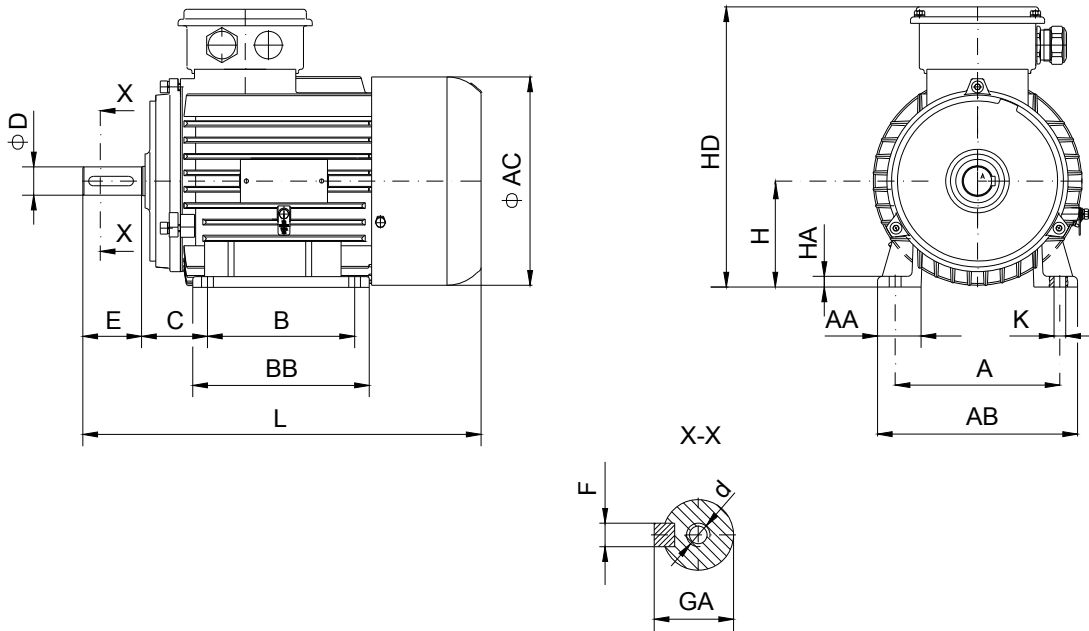

Frame size	Dimensions (mm)																
	Foot mounting								Shaft extension					HD max	AC	L max	
A	B	C	H	K	AA	AB	BB	HA	D	E	F	GA	d				
90L-4	140	125	56	90	10	37	170	150	9	24j6	50	8h9	27	M8	272	177	411

**The overall and mounting dimensions
IM 3001; IM 3011**

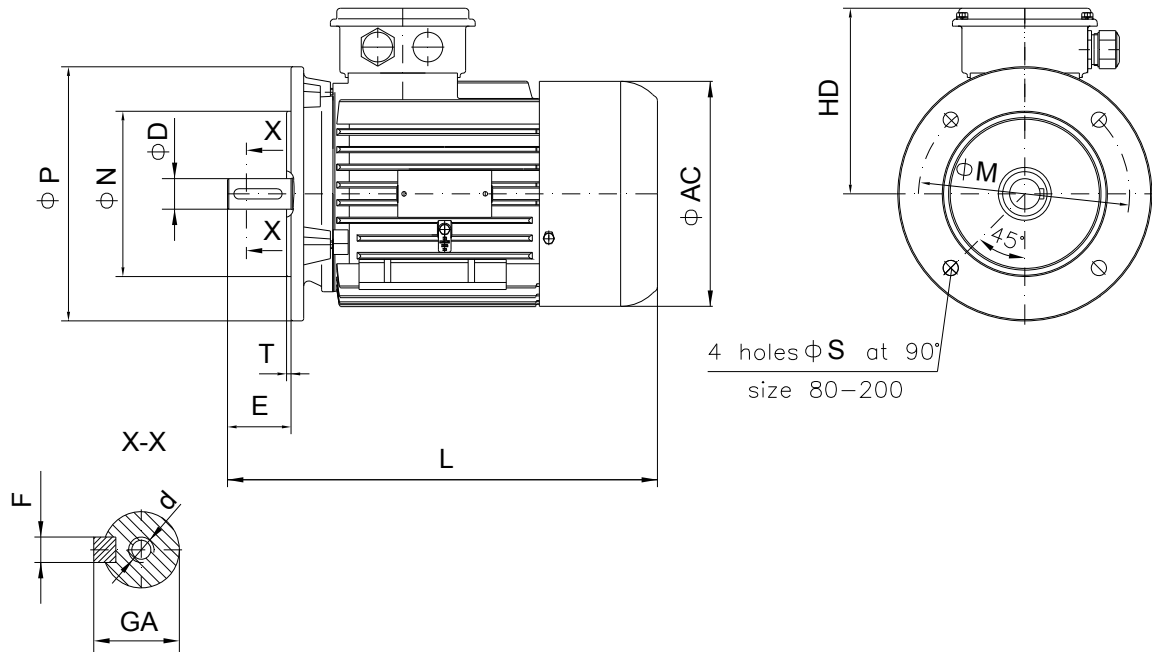

Frame size	Dimensions (mm)											HD max	AC	L max
	Flange mounting (B5)					Shaft extension								
	N	M	P	S	T	D	E	F	GA	d				
90L-4	130j6	165	200	12	3.5	24j6	50	8h9	27	M8	182	177	411	

**The overall and mounting dimensions
IMB35**



Frame size	Dimensions (mm)															HD max	AC	L max
	Foot mounting					Flange mounting					Shaft extension							
	A	B	C	H _{0.5}	K	N	M	P	S	T	D	E	F	GA	d			
90L-4	140	125	56	90	10	130	165	200	12	3.5	24j6	50	8h9	27	M8	272	177	411